

Lab comes to you

What's New and Trends: Application Integration and iPaaS

Leif Davidsen
Program Director, Product Management,
Cloud Pak for Integration

Market trends

Digital Boom

\$6.3 tn about **55%** of total global IT investment going into DX between 2022-24.

53% of enterprises having enterprise-wide DX strategy, **42% increase since 2019.**



IDC FutureScape: Worldwide Digital Transformation 2022 Predictions

Application Explosion

80% of the organizations estimate they have **over 100 applications** in their portfolio today.

54% of applications will be **replaced and modernized to cloud** environment in 3 years.



IDC Survey: Worldwide Application Services, 2021

Workforce expansion

By 2026, **developers** outside IT will account for 80% of the user base of low-code dev tools

By 2023, **65%** of large organizations will enable their **non-IT personnel to perform integration tasks.**



Gartner Forecast Analysis: Low-code Dev, Technologies, Oct 2022; Future of Work Trends: Tinkerers Become Mechanics



Enabling collaboration and self-service across business & IT



Business Integrators



Business technologist

Need low-code, high productivity tools to rapidly assemble integrations

Technology Integrators



App / API developer

Need smart tooling to access and expose back-end data

Integration expert

Need powerful IDE including graphical tools & custom coding

Integration architect

Need power tools to support wide range of integrations

Integration Capabilities

IBM App Connect



Unlock the value of your system and data by connecting business applications, integrating data, building APIs and acting on events

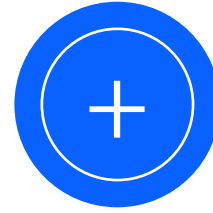

Build

Quickly build and test integration flows with authoring tools for both integration experts and business technologists



Connect

Securely connect with hundreds of applications on cloud and on-premise with pre-built smart connectors and templates



Transform

The fastest performing engine that virtually supports any-to-any data format. Offers AI-infused, smart tooling for non-specialist

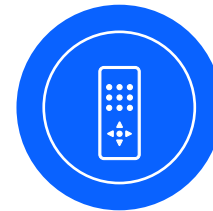

Manage

Easily deploy integrations using ESB or microservices with visibility into flow health and performance across hybrid environments

Complimentary authoring experiences support workforce expansion

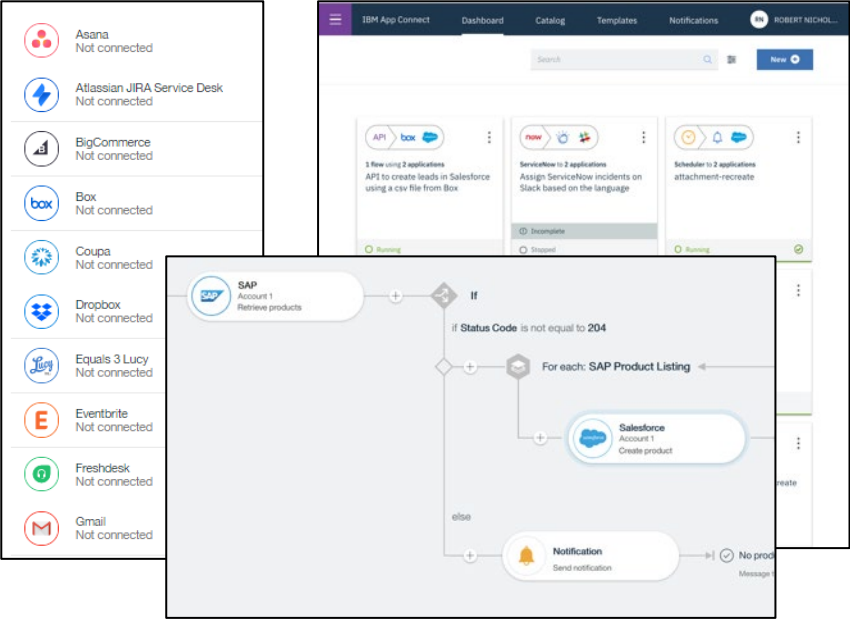

Designer for business technologists

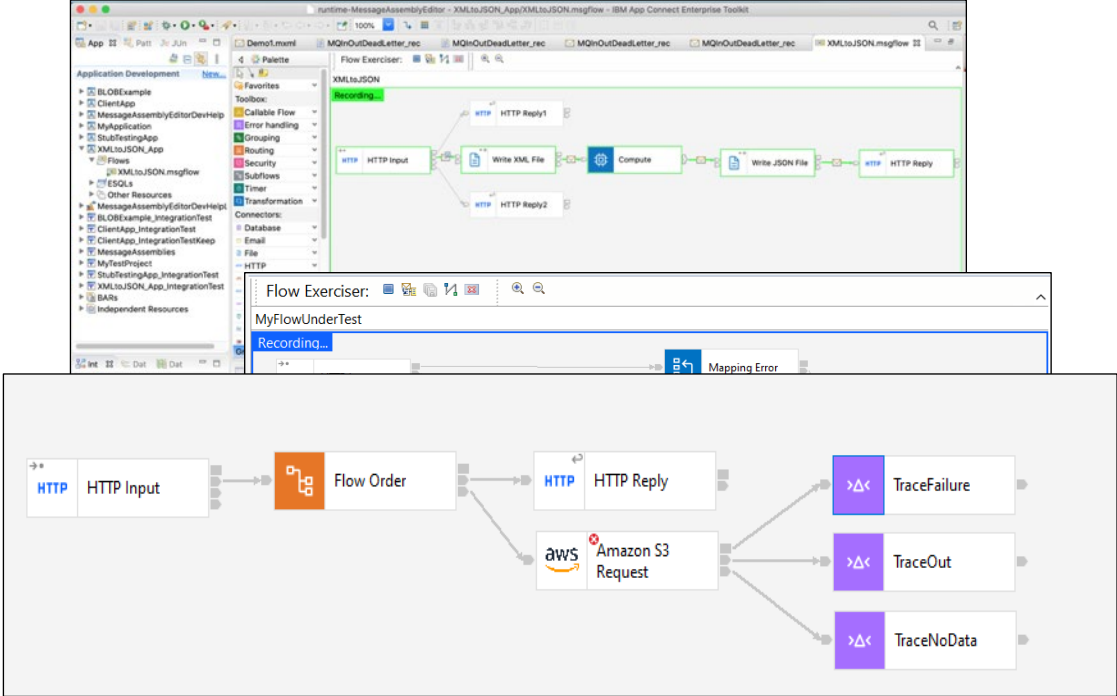

Toolkit for integration experts

Easily deploy and manage across hybrid environments

View integrations across any hybrid cloud deployment

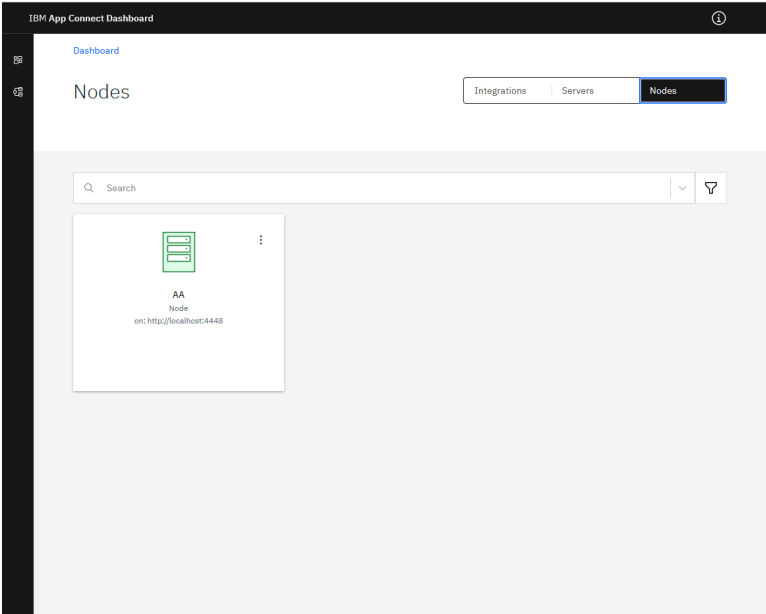

Single unified pane

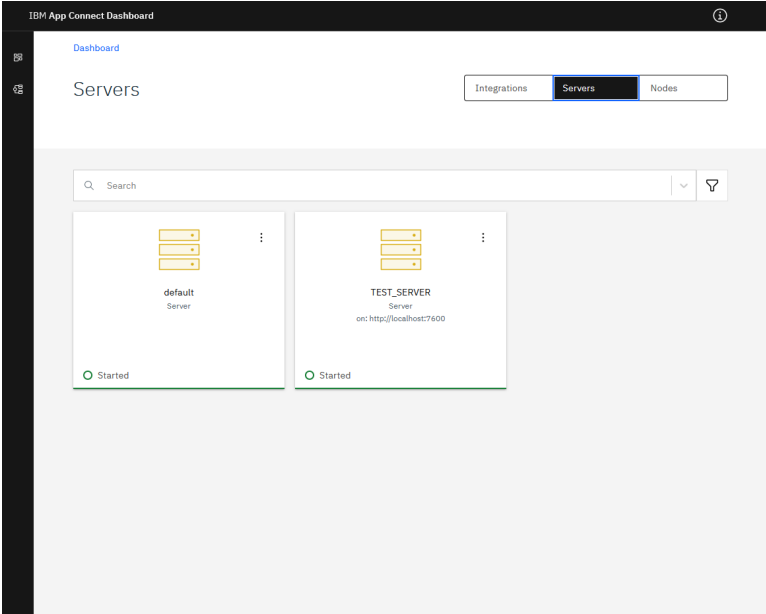

Faster problem determination

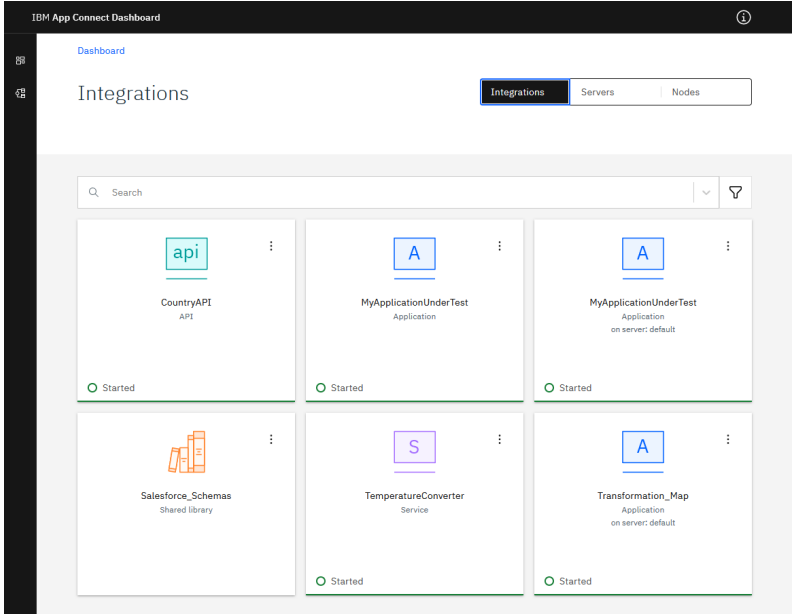

Instantly identify health

Automate end-to-end with DevOps ready features

Build automated deployment pipelines and achieve unprecedented acceleration of project timelines

- ✓ Comprehensive set of mature APIs and CLIs to control each aspects of integration lifecycle
- ✓ New `ibmint` command family to help build source to server pipeline
- ✓ Integrate and run tests from unit test framework as part of pipelines
- ✓ Fully compatible with DevOps tools of choice



Available with choice and flexibility



IBM Cloud Pak for Integration

Consume application integration capabilities in a unified integration platform, on OpenShift anywhere



App Connect software

Deploy on-prem on X/P/Z or any cloud infrastructure, bring your own OpenShift, other K8s platforms, Docker or VM

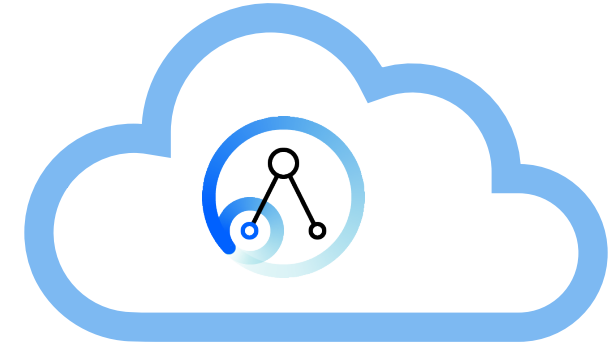

IBM App Connect as a Service (iPaaS)

Consume a highly available, multi-tenant service fully managed, maintained and operated by IBM

What's new

What's new



Integrate & automate faster with AI

- AI field mapping (map assist)
- AI data mapping (data assist)
- Create flows using natural language

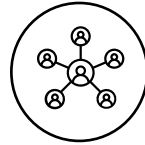

Leverage your data more effectively

- An API-Led experience for integration (Unified Authoring)
- 100s of new connectors in Designer
- 25+ new connectors in Toolkit
- Develop your own custom connectors (CDK)
- Connector community with ability to consume & contribute connectors



Consuming integration solutions on cloud

- Optimized integration runtimes in containers, built for cloud/K8s deployments
- Brand new ACE SaaS (iPaaS)
- Purchase and deploy on public clouds and from marketplaces (AWS)

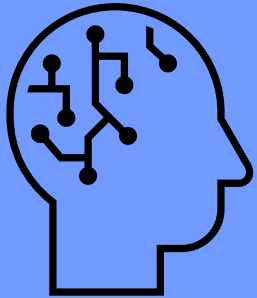

Integrate & automate faster with AI

AI Automation Feature Benefits

| Simplification |

AI Automation feature benefits

- **Improved productivity** - Reclaim more than 50% of your developer time with intelligent automations
- **Reduced learning curve** - Free up employees to focus on what they do best and get them going from the word “Go”
- **Eliminate skills barrier** - Make technology accessible to everyone within your organization including non-experts
- **Boost confidence in decisions** - Developers make better, faster informed decisions with insight-driven recommendations
- **Faster time to market** - Empower your developers to deliver projects 33% faster compared to any other existing solution



Simplify with AI

- Simplify field mapping between applications
- Easily transform data to and from JSON, XML and flat files
- Inline guidance and recommendations
- Generate flows using natural language

Receive suggested mappings

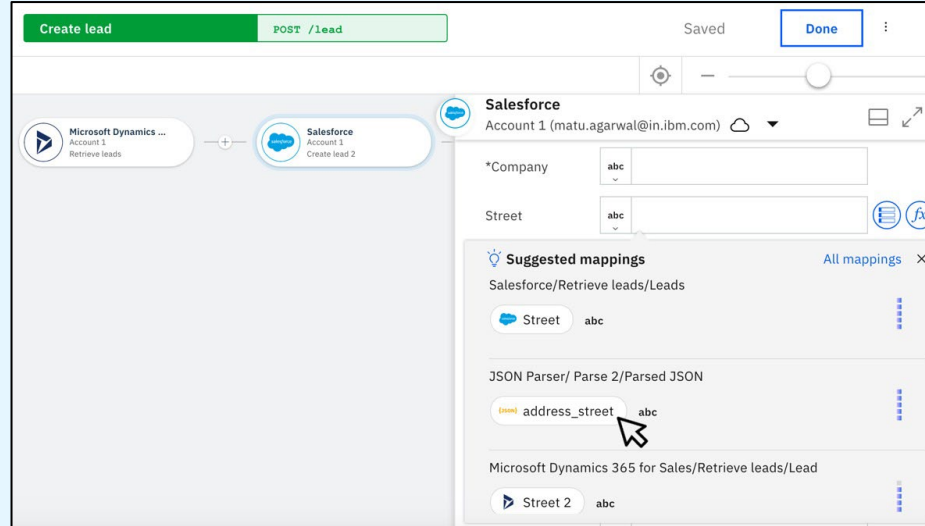

Quickly transform data

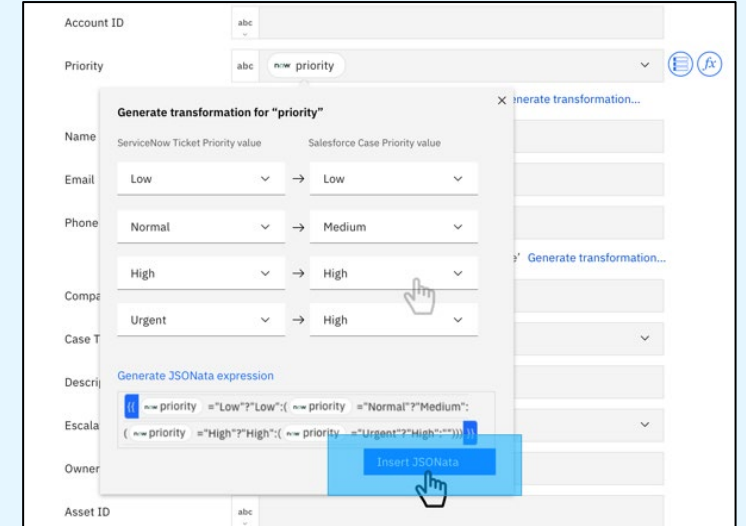

View guidance in line

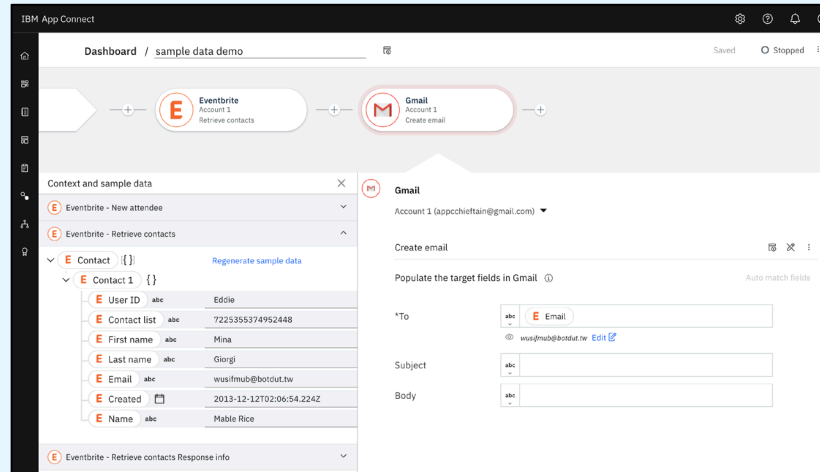

Generate flow by describing it

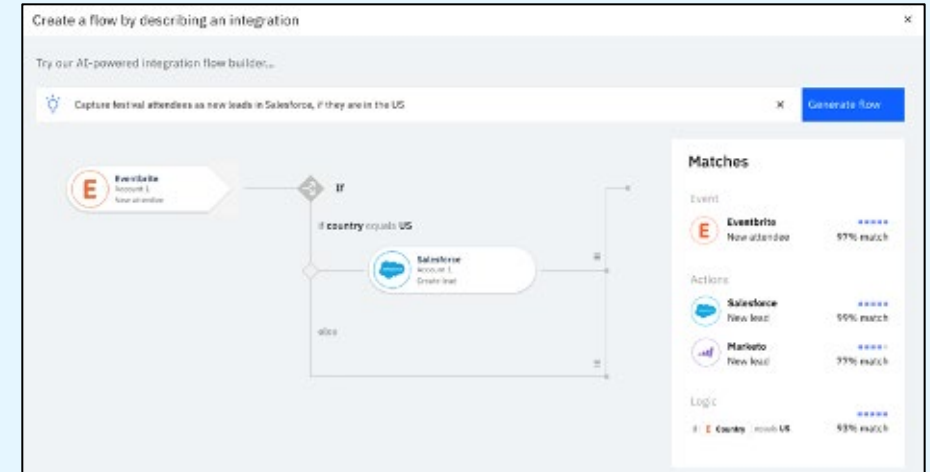

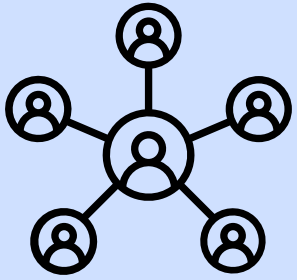

Leverage your data more effectively

Unified Authoring

Connectors

Connector Development Kit

APIs are a key enabler of digital transformation & integration

API-led integration is a modern way to integrate applications and data through reusable APIs.

It replaces the overly complex point-to-point integration style to enable a more flexible, scalable and agile architecture.



Reduce cost by leading with APIs as the building blocks of integration



Quickly adapt to changing business needs by leveraging OpenAPI standards



Manage, secure, & share your APIs more efficiently & effectively

Business & IT Integrators

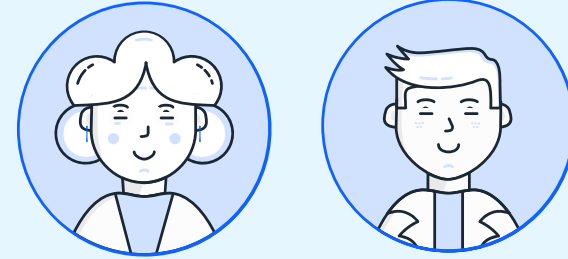

Design, Implement, Deploy APIs & Flows

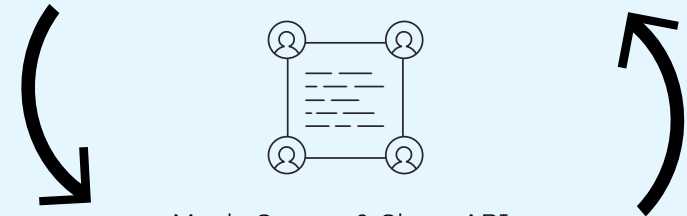

Mock, Secure & Share APIs



API Developers

Unified API Authoring Experience

Seamlessly build, secure and share REST API implementations

Define your OpenAPI

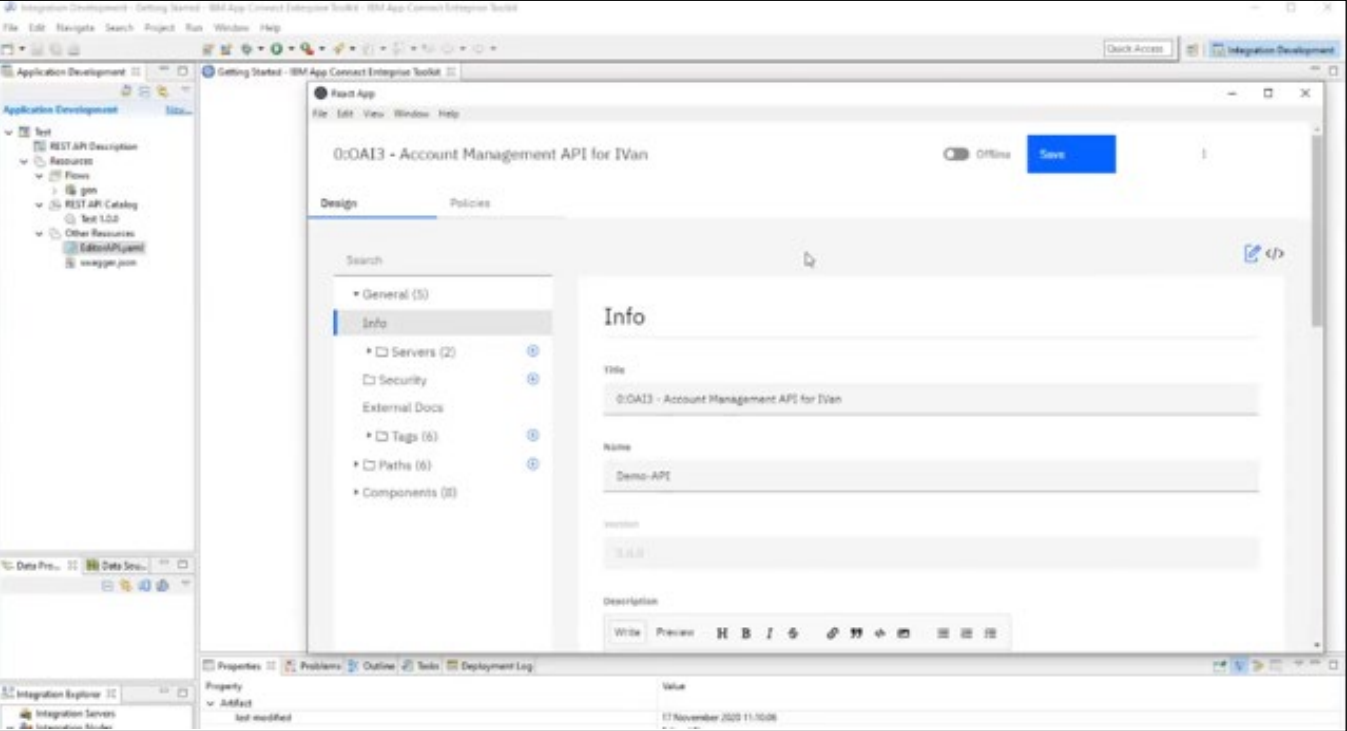

Build your API flows

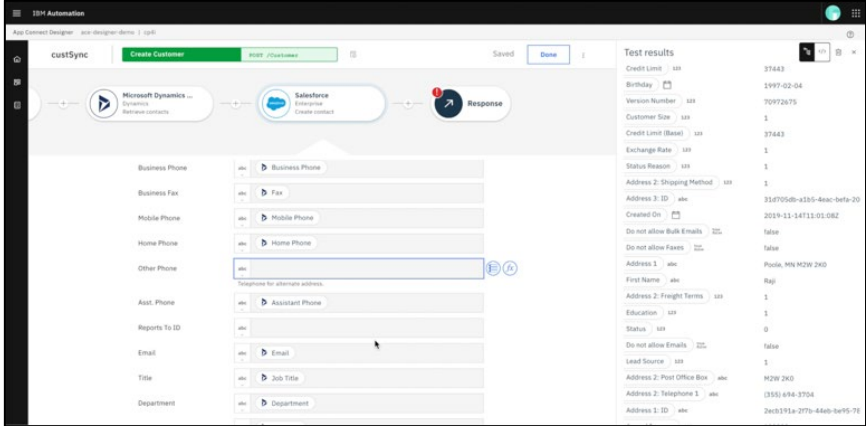

Secure with gateway policies and publish for reuse

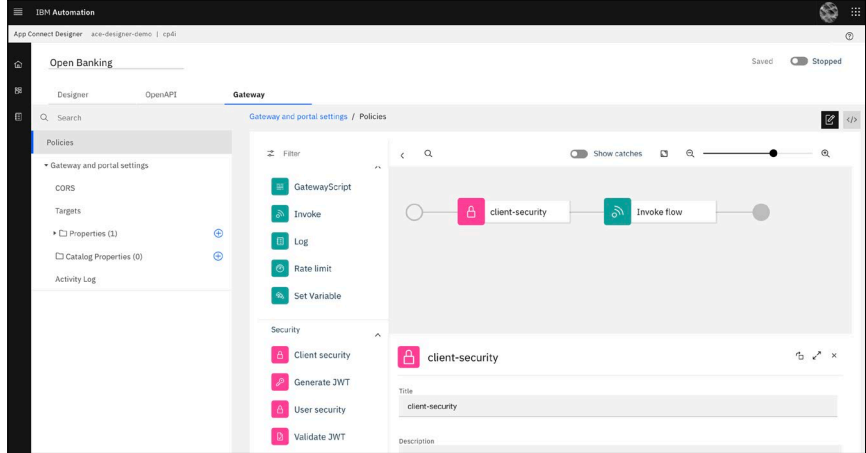

Connectors play a key role in integrating applications, building APIs and acting on events

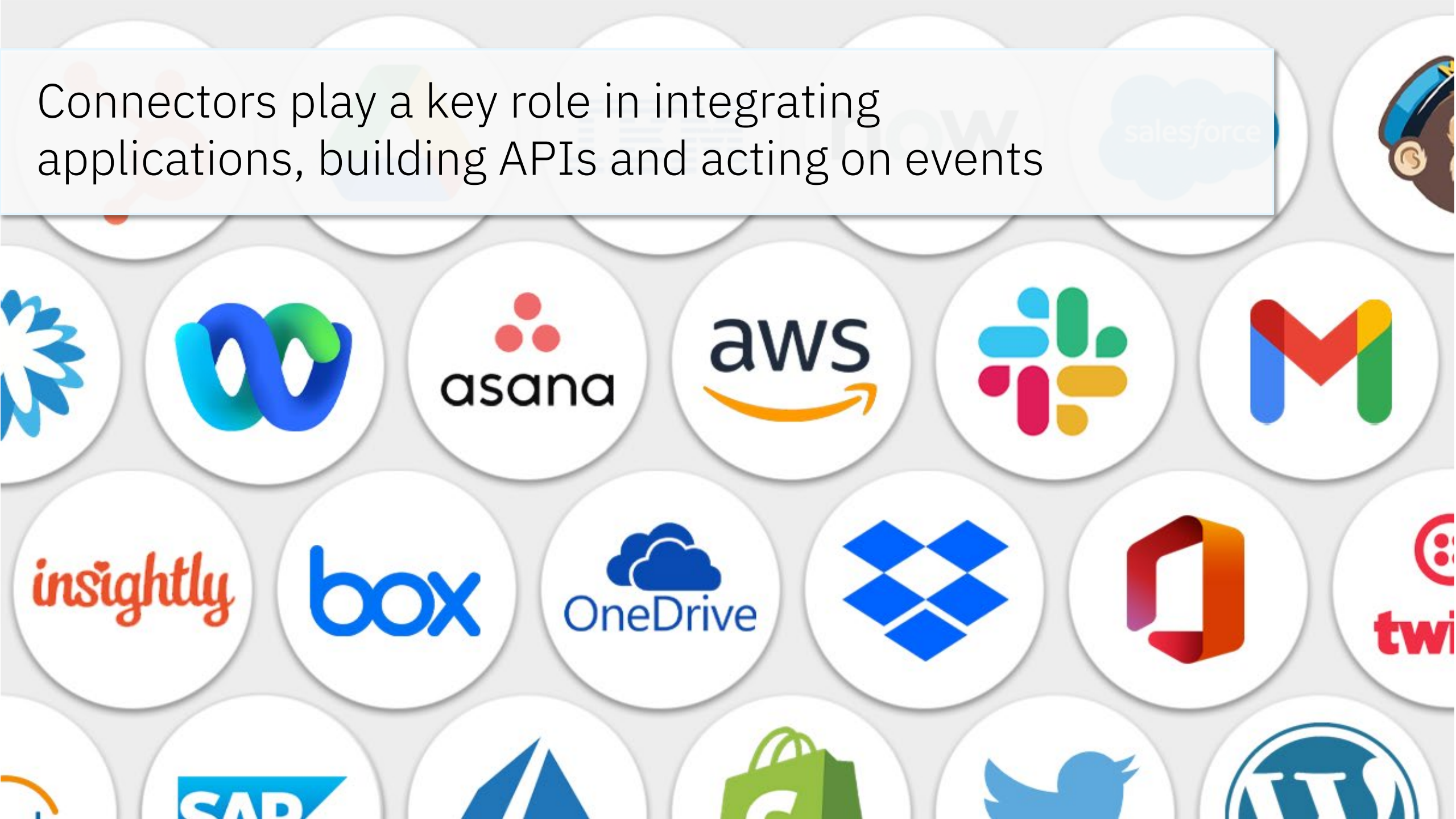

What's new with Connectors

- Additional connectors provide more connectivity options to enterprise-apps
- New experience to discover and explore community connectors in Automation Explorer
- New low-code Connector Development Kit enables you to build your own connectors

Use even more connectors in Designer or Toolkit

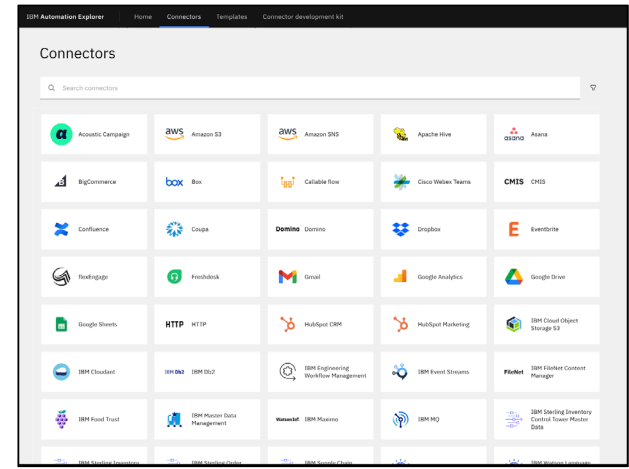
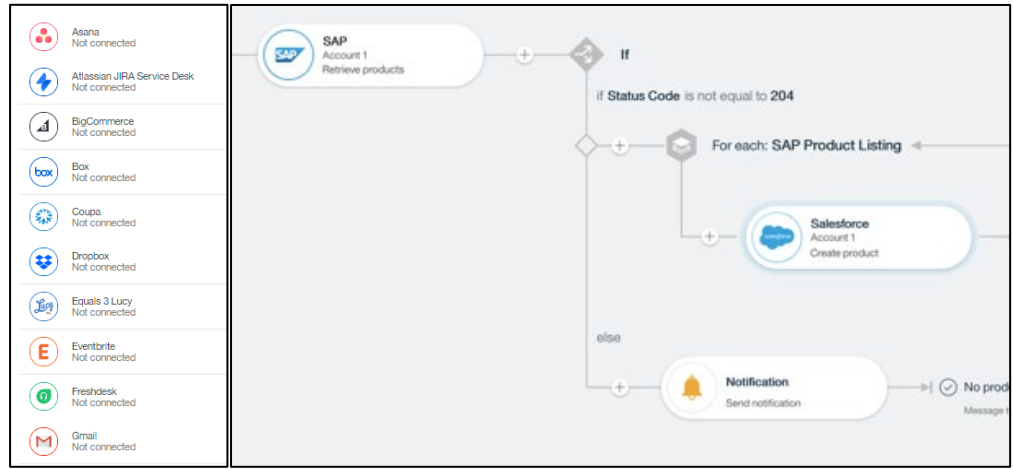

Discover more connectors

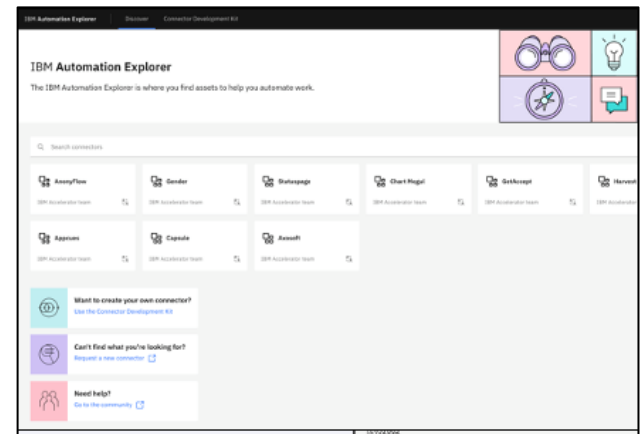

Learn and explore

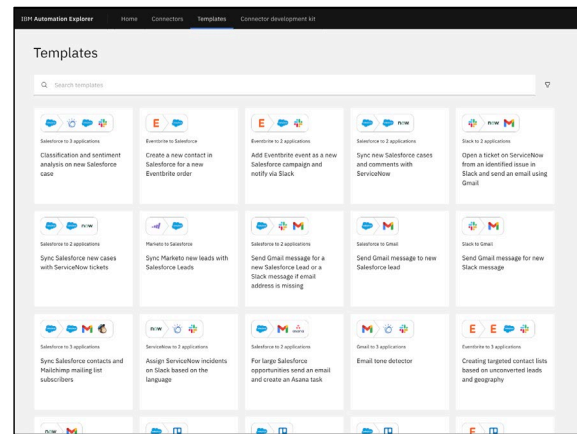

Build your own

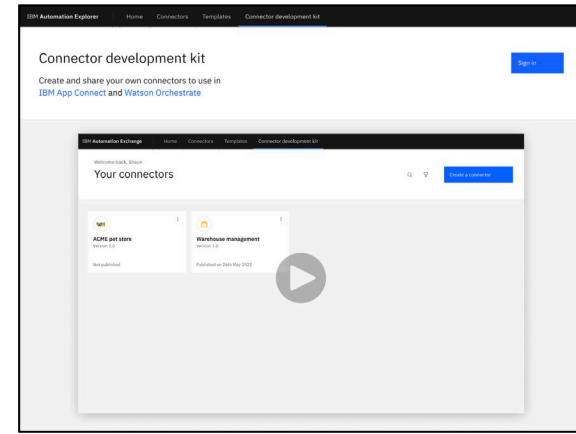

Leverage 200+ Connectors & Templates to jumpstart your integration

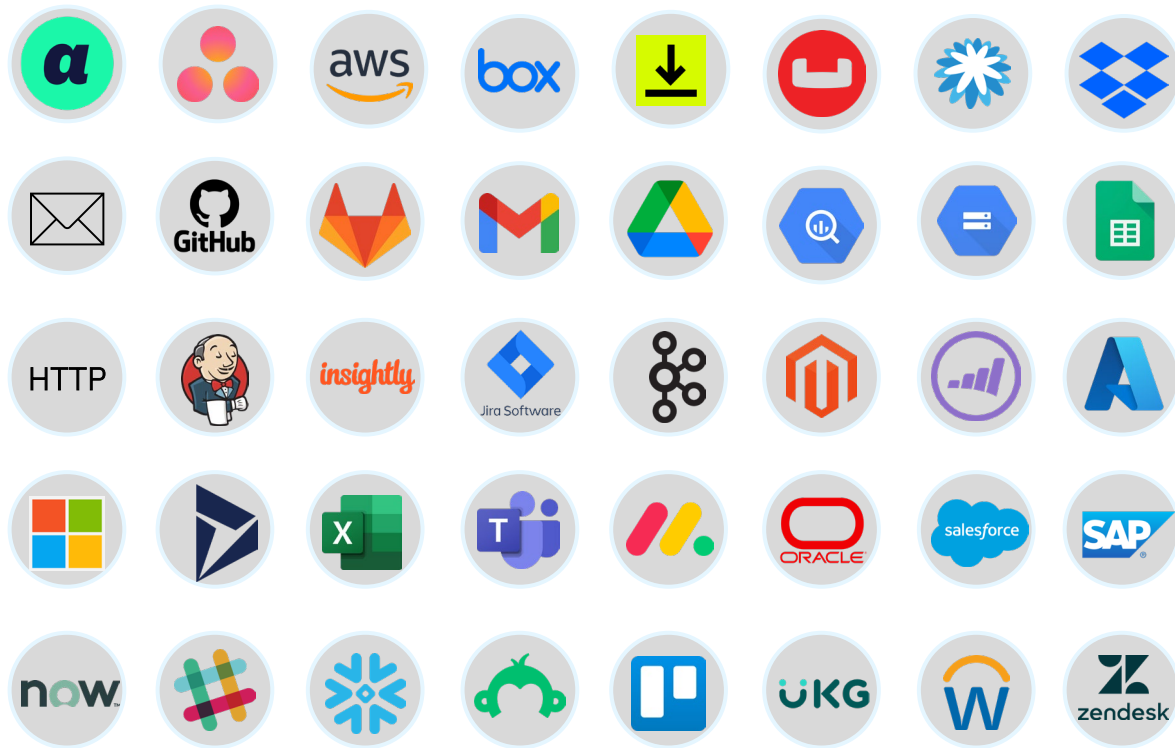

- Connectors pre-built for business-critical apps both SaaS and on-prem
- Connectors pre-built for technologies like databases and messaging when you need to understand interfaces to different systems
- Templates make it faster and easier to combine connectors to create integration flows
- Connectors created by our user community, built using Connector Development Kit

Connectors now in Toolkit

- Pre-built, smart connectors natively supported directly within Toolkit
- Integrate with pre-packaged cloud and on-premise apps with smart connectors without coding
- Use these smart connectors natively with other Toolkit features and capabilities
- Deploy these connectors and integration flows in ESB architecture on VMs or as microservices on containers/K8s platform
- Smart connectors and flows supported on all platforms supported by App Connect Enterprise
- New tutorials added as we go

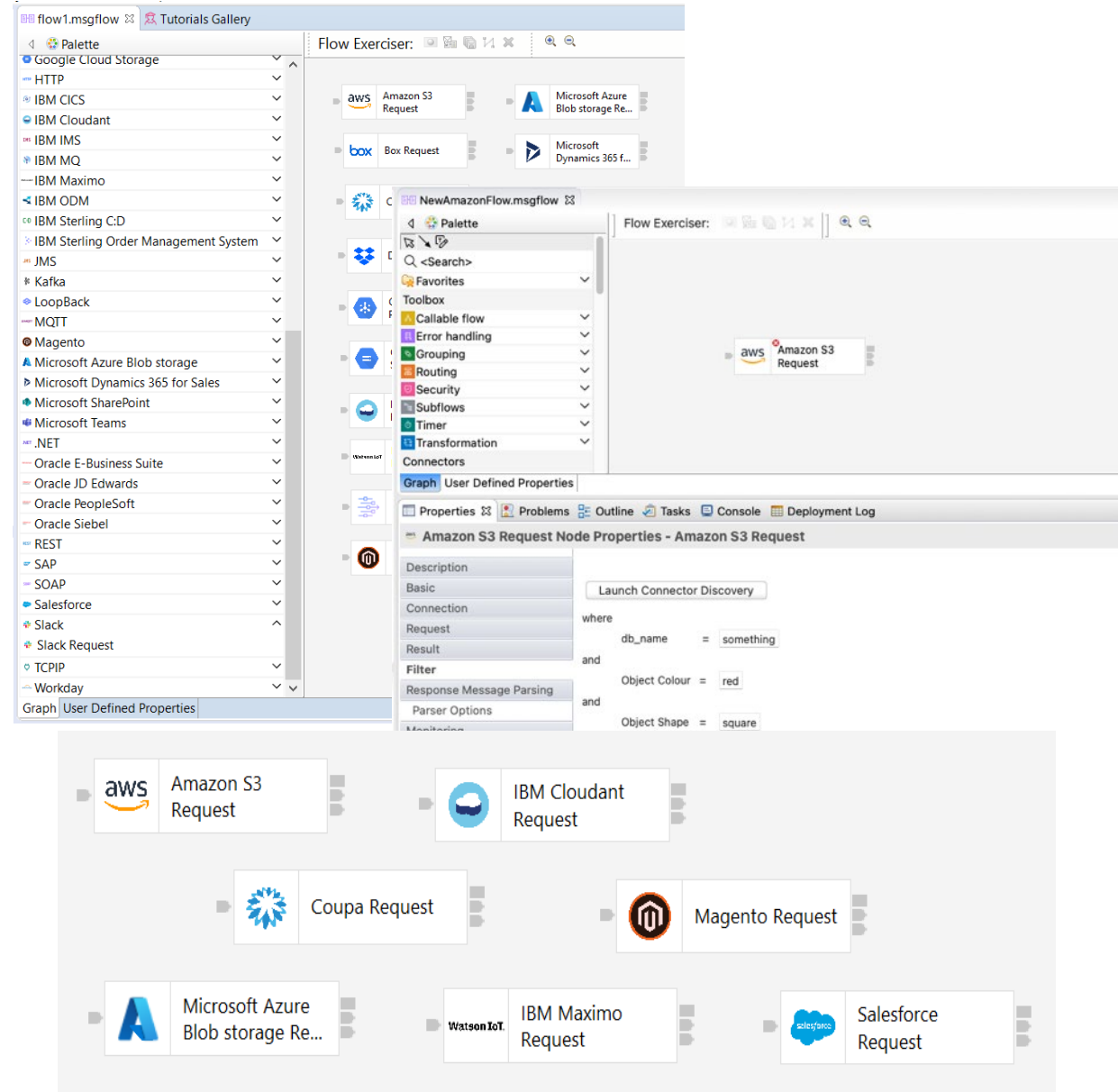

IBM Connector Development Kit

A simple to use, low-code developer experience that enables you to build your own connectors in less than a day.



Build connectors from an Open API document or from scratch

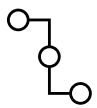

Consume your connectors in App Connect, and extend the capabilities provided OOTB with unique requirements your business may have



Contribute to the connector ecosystem benefiting the global community

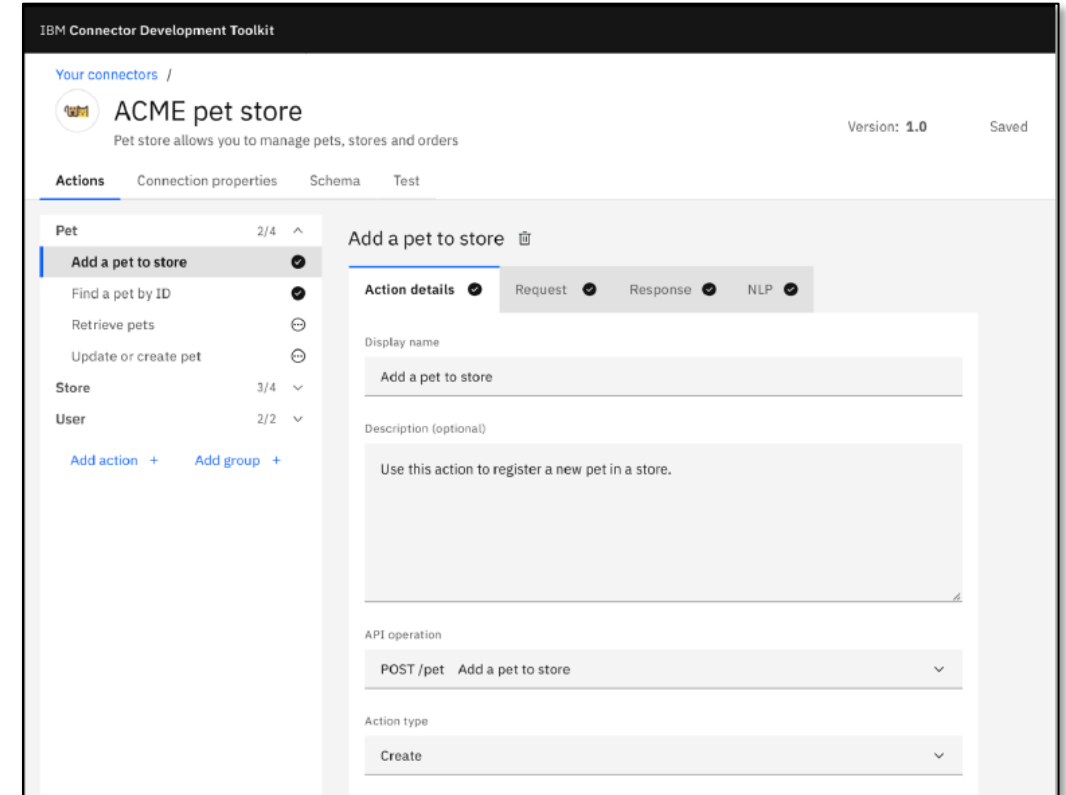



Consuming integration solutions on cloud

Optimizing your integration runtimes in containers

| App Connect Enterprise SaaS |

Optimize your Integration Runtimes

- New **dynamic resource management** allows complete control over which capabilities are started in container
- **Provide finer-grained control** to create more granular and light weight integration microservices
- **Reduce footprint, quicker startup** with certain workloads starting up in 1 second
- **Save on CPU** and memory cost by reducing overhead
- **New command** - `ibmint optimize server`
- **Generate new configuration** - `server.component.yaml` by examining working directory content
- **v12.0.4+**

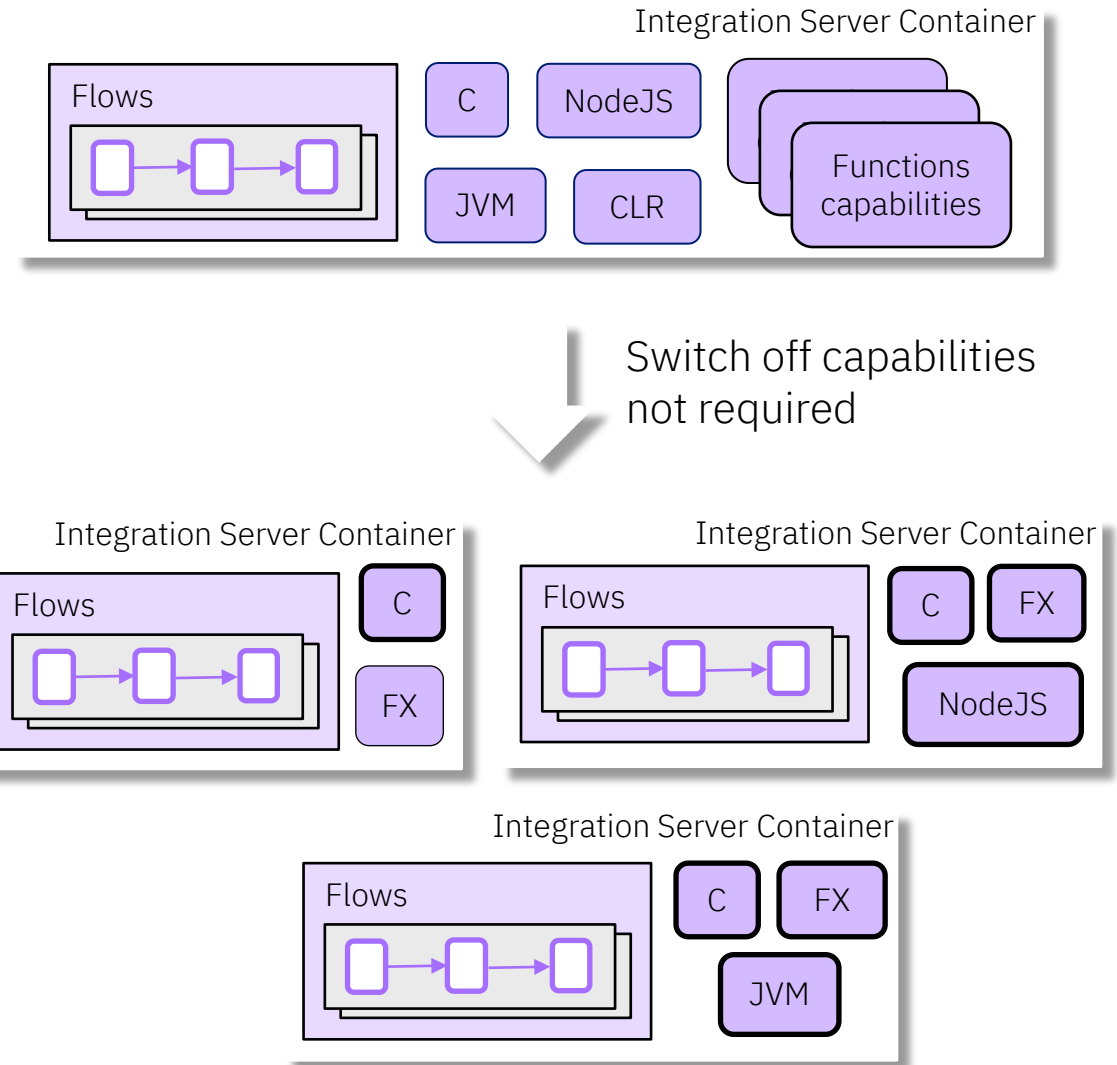

App Connect Enterprise as a Service (iPaaS)

- ✓ Free 30-day trial available in all three regions
- ✓ Provision in US, EU, or UK Regions on AWS
- ✓ VPC-hour + premium connector pricing, annual term
- ✓ Multi-tenant SaaS with the benefits of isolation for deployed integrations
- ✓ Hybrid connectivity included with secure agents
- ✓ All premium and technology connectors available
- ✓ Get started quickly with templates and AI productivity features
- ✓ Discover community connectors in [IBM Automation Explorer](#)
- ✓ Develop custom connectors yourself with a low-code CDK
- ✓ And so much more ...

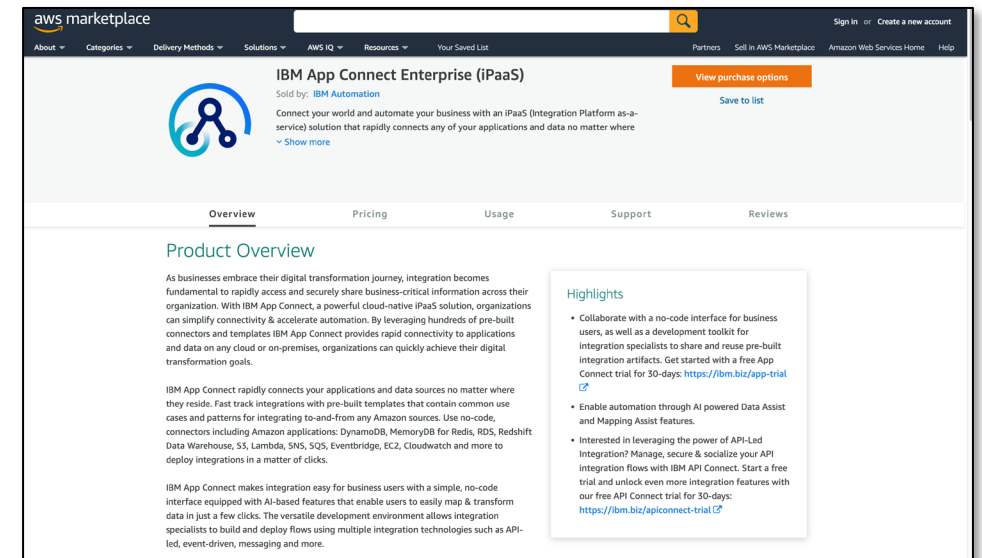
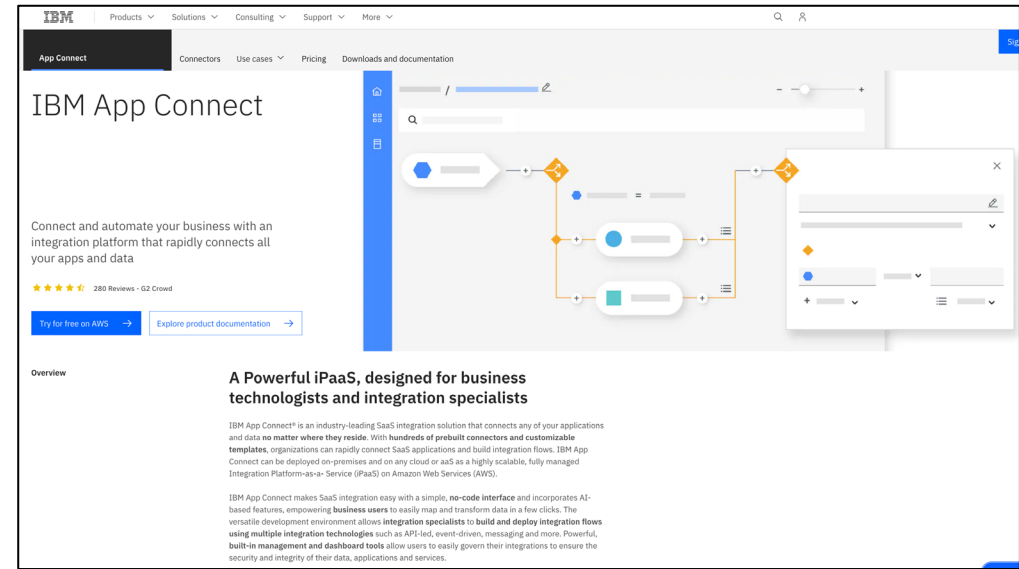

Resources

Learn more about App Integration

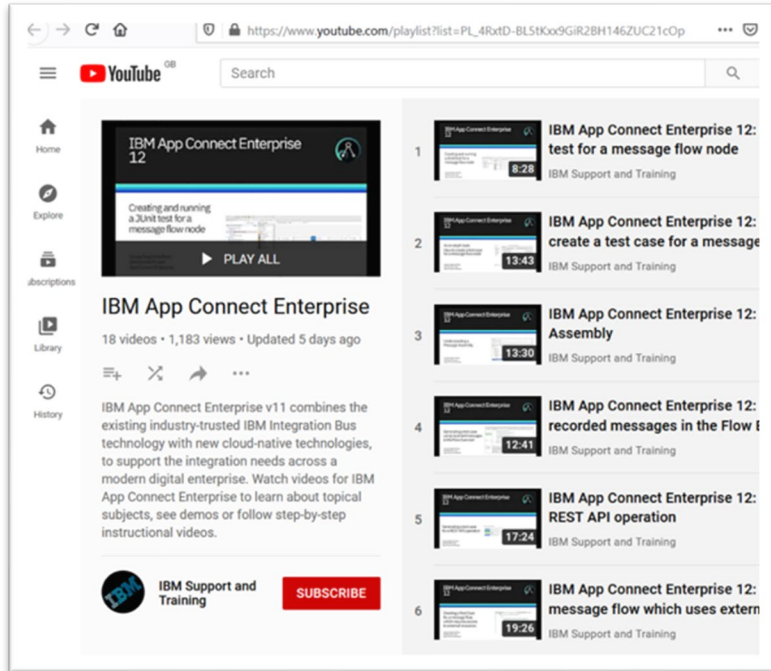

YouTube Playlist:

Latest features with how-to tutorials
App Connect Enterprise V12: [URL](#)
App Connect Designer: [URL](#)

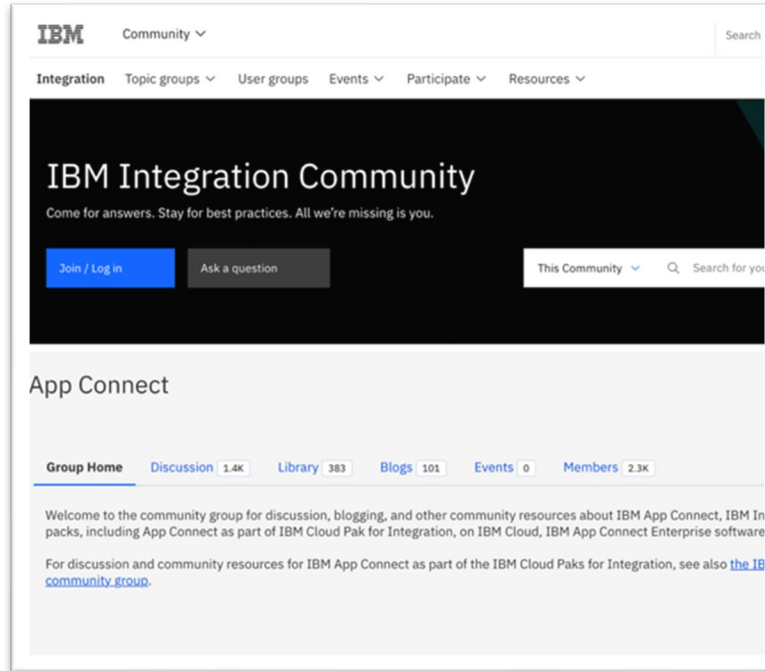

Community:

2700+ members
1900+ discussions
App Connect Community: [URL](#)

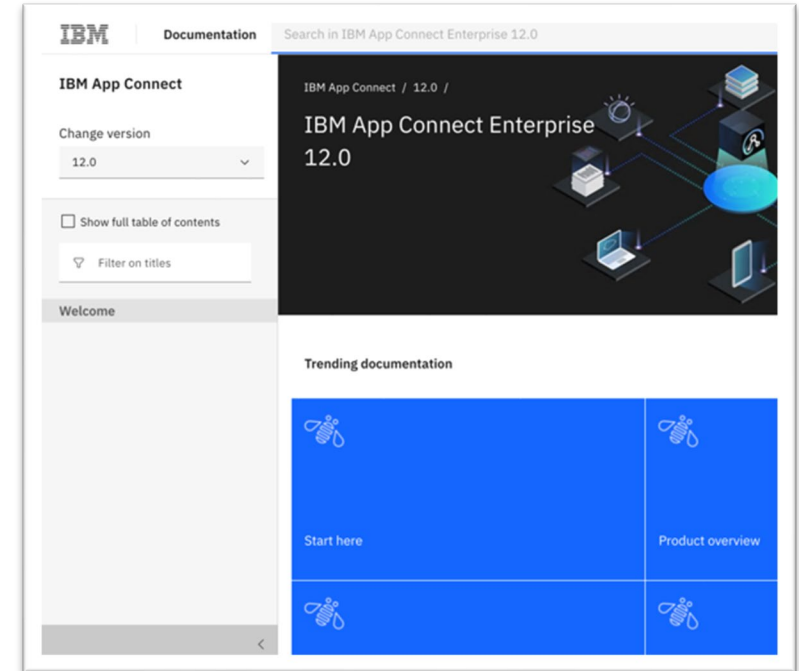

Documentation:

ACE V12 software: [URL](#)
ACE on containers: [URL](#)
ACE migration to CP4I: [URL](#)

Try it hands on!

IBM App Connect free trial

Try IBM App Connect for free for 30 days and learn how you rapidly connect apps and data sources across your enterprise.

[Free trial >>](#)

IBM Automation Explorer & CDK

IBM Automation Explorer is where you find assets to help you automate work and develop a community connector via connector development kit.

[Visit IBM Automation Explorer >>](#)

Contact IBM

Let IBM show you how you can get more from your APIs while driving your digital transformation.

[Contact us >>](#)

Thank you.

IBM